



Equipement de sol Bodemuitrusting

Nicoll

aliaxis



Equipement de sol

Bodemuitrusting

SIPHONNETTES POUR L'INTÉRIEUR	298	VLOERPUTJES VOOR BINNEN
SIPHONS DE COUR PVC POUR L'INTÉRIEUR ET L'EXTÉRIEUR	300	PVC VLOERPUTTEN VOOR BINNEN EN BUITEN
SIPHONS DE COUR PP POUR L'INTÉRIEUR ET L'EXTÉRIEUR	303	PP VLOERPUTTEN VOOR BINNEN EN BUITEN
SOLUTIONS POUR BALCONS	305	OPLOSSINGEN VOOR BALKONS
SOLUTIONS SPÉCIALES	306	SPECIALE OPLOSSINGEN



SIPHONNETTES POUR L'INTÉRIEUR VLOERPUTJES VOOR BINNEN

M S Siphonnette avec sortie horizontale PVC Vloerputje met sifon met horizontale uitgang PVC

SOSICO



> Livré sans cadre

> Geleverd zonder kader

Ø male spie	Grille Rooster	H			Ref.		
Siphonnette - Vloerput							
32	Ø 87	82	50	Gris/Grijs	SICF	10	
40	Ø 87	82	50	Gris/Grijs	SICH	10	
Cadre/Kader							
100 x 100					Gris/Grijs	PLC10FH	10

M S Siphonnette avec sortie verticale PVC Vloerputje met sifon met vertikale uitgang PVC

SOSICO



> Livré sans cadre

> Geleverd zonder kader

Ø male spie	Grille Rooster			Z	L	Ref.	
Siphonnette/Vloerput							
32	Ø 98	26	Gris/Grijs	49	22	SIF	10
40	Ø 98	22	Gris/Grijs	49	22	SIH	10
50	Ø 114	27	Gris/Grijs	60	37,5	SIJ	10
Cadre - Kader SIF-SIH							
100 x 100			Gris/Grijs			PL10FH	10
150 x 150			Gris/Grijs			PL15FH	10
Cadre - Kader SIJ							
150 x 150			Gris/Grijs			PL15J	10
200 x 200			Gris/Grijs			PL20J	10
250 x 250			Gris/Grijs			PL25J	10

M-F Siphonnette avec sortie verticale PVC M-S Vloerputje met sifon met vertikale uitgang PVC

SOSICO



N°	Ø male spie	Ø fem. mof	Platine Tegel	H			Ref.		
Grille + cadre PVC / Kader + rooster PVC									
4	93/40	50	100 x 100	57	28	0,7	Antrac.	SIHJ10A	10
3	93/40	50	100 x 100	57	28	0,7	Blanc	SIHJ10	10
Grille Inox + cadre PVC / Rooster Inox + kader PVC									
2	93/40	50	100 x 100	57	28	0,7	Inox	SIHJ10I	10
Grille + cadre Inox / Kader + rooster Inox									
1	93/40	50	100 x 100	57	28	0,7	Inox	SIHJ10CI	10

M-F Adaptateur siphonnette sortie horizontale PVC M-S Onderstel met horizontale uitloop PVC

SOSICO





Ø male spie	Ø fem. mof	Blanc/Wit	H min.	H max.	Ref.	
50	40	Blanc/Wit	77	85	ADSIHJ	1

> Pour siphonnettes SIHJ10 / SIHJ10I / SIHJ10CI

> Voor vloerputten SIHJ / SIHJ10I / SIHJ10CI



M-F Siphonnette avec sortie verticale PVC
M-S Vloerputje met sifon met verticale uitgang PVC



N°	Ø male spie	Ø fem. mof	Platine Tegel	H			Ref.		SOSICO
Grille + cadre PVC gris foncé / Rooster + kader donker grijze PVC									
1	50	40	105 x 105	91,3	50	0,44	24058	25	
Grille Inox + cadre PVC gris foncé / Rooster Inox + donker grijze kader PVC									
2	50	40	105 x 105	91,3	50	0,44	24048	25	

> Réduction Ø 40 incluse

> Reductie Ø 40 inbegrepen



F Siphonnette avec sortie horizontale PVC
M Vloerputje met sifon met horizontale uitgang PVC



N°	Ø fem. mof	Platine Tegel	H		L	Ref.		SOSICO
Grille + cadre PVC gris foncé / Rooster + kader donker grijze PVC								
1	50/40	105 x 105	84	50	127	24038	10	
Grille Inox + cadre PVC gris foncé / Rooster Inox + donker grijze kader PVC								
2	50/40	105 x 105	84	50	127	24028	25	

> Réduction Ø 40 incluse

> Reductie Ø 40 inbegrepen





M Siphon de sol ultra plat orientable avec sortie horizontale
S Ultra platte draaibare vloerput met horizontale uitgang roos

Platine Tegel	Corps Lichaam	Ø	Ø male spie		H	Ref.		SOSICO
150 x 150	135		40	INOX	72	E2242AI	12	
150 x 150	135	40		Gris foncé Donkergrijs	72	E224204	12	
150 x 150	135		50	INOX	72	E2250AI	12	
150 x 150	135	50		Gris foncé Donkergrijs	72	E225004	12	





M Siphon de sol bas orientable avec sortie horizontale PP/INOX
S Lage draaibare vloerput met horizontale uitgang PP/INOX

Platine Tegel	Corps Lichaam	Ø male spie		H	Ref.		SOSICO
100 x 100	90	40	INOX	80	E2240AI	12	
100 x 100	90	50	INOX	80	E2245AI	12	



F Siphon de sol pour raccord sur manchon de tube PP/INOX
M Vloerput voor aansluiting op buismof PP/INOX

Platine Tegel	Ø		H min.	H max.		Ref.		SOSICO
100 x 100	100/125	INOX	45	110	0,4	EFS10AI	1	
150 x 150	100/125	INOX	45	110	0,4	EFS15AI	1	

> Epaisseur de la platine + grille: 13mm

> Dikte van de kader + rooster: 13mm





SIPHONS DE COUR PVC POUR L'INTÉRIEUR ET L'EXTÉRIEUR PVC VLOERPUTTEN VOOR BINNEN EN BUITEN

M-F Siphon de cour à emboîture incorporée PVC M-S Vloerput met inwendige aansluiting PVC

SOSICO

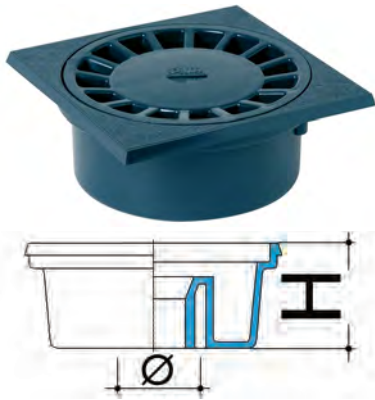

Platine Tegel	Grille Rooster	Ø male spie	Ø fem. mof		H		Ref.	
150 x 150	139	50	40/63	Gris foncé Donkergrijs	63	21	SC456	6
150 x 150	139	50	40/63	Sable Zand	63	21	SC456S	6
150 x 150	139	50	40/63	Gris clair Lichtgrijs	63	21	SC456G	6
150 x 150	139	50	40/63	Blanc Wit	63	21	SC456B	6
200 x 200	182	80	90	Gris foncé Donkergrijs	92	36	SC089	4
200 x 200	182	80	90	Sable Zand	92	36	SC089S	4
200 x 200	182	80	90	Gris clair Lichtgrijs	92	36	SC089G	4
250 x 250	230	90	80/100	Gris foncé Donkergrijs	96	36	SC891	4
250 x 250	230	90	80/100	Sable Zand	96	36	SC891S	4
250 x 250	230	90	80/100	Gris clair Lichtgrijs	96	36	SC891G	4

M-F Siphon de cour grande garde d'eau avec sortie verticale PVC M-S Vloerput met groot waterslot met verticale uitgang PVC

SOSICO

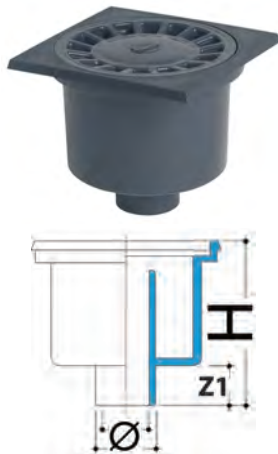

Platine Tegel	Grille Rooster	Ø male spie	Ø fem. mof		H		Z1	Ref.	
150 x 150	139	50	40	Gris foncé Donkergrijs	131	60	32	SC54	6
200 x 200	179	75	63	Gris foncé Donkergrijs	150	60	45	SC76	4
250 x 250	229	100	90	Gris foncé Donkergrijs	172	60	57	SC109	4



M-F Siphon de cour avec sortie verticale PVC
M-S Vloerput met verticale uitgang PVC

Platine Tegel	Grille Rooster	∅ male spie	∅ fem. mof		H		Z1	Ref.		SOSICO
100 x 100	92	40	32	Gris clair Lichtgrijs	79	17	32	SC403G	18	
150 x 150	139	50	40	Gris foncé Donkergrijs	88	17	32	SC504	6	
150 x 150	139	50	40	Gris clair Lichtgrijs	88	17	32	SC504G	6	
150 x 150	139	50	40	Sable Zand	88	17	32	SC504S	6	
200 x 200	179	75	63	Gris foncé Donkergrijs	110	19,5	45	SC756	4	
200 x 200	179	75	63	Gris clair Lichtgrijs	110	19,5	45	SC756G	4	
200 x 200	179	75	63	Sable Zand	110	19,5	45	SC756S	4	
250 x 250	229	90	80	Gris foncé Donkergrijs	134	26	52	SC908	4	
250 x 250	229	90	80	Gris clair Lichtgrijs	134	26	52	SC908G	4	
250 x 250	229	90	80	Sable Zand	134	26	52	SC908S	4	
250 x 250	229	100	90	Gris foncé Donkergrijs	139	26	57	SC1009	4	
250 x 250	229	100	90	Gris clair Lichtgrijs	139	26	57	SC1009G	4	
250 x 250	229	100	90	Sable Zand	139	26	57	SC1009S	4	
250 x 250	229	110	100	Gris foncé Donkergrijs	143	26	61	SK1110	6	
250 x 250	229	110	100	Gris clair Lichtgrijs	143	26	61	SK1110G	6	
250 x 250	229	110	100	Sable Zand	143	26	61	SK1110S	6	
300 x 300	230	110	100	Gris foncé Donkergrijs	183	50	61	SC1110	2	
300 x 300	230	110	100	Gris clair Lichtgrijs	183	50	61	SC1110G	2	
300 x 300	230	110	100	Sable Zand	183	50	61	SC1110S	2	

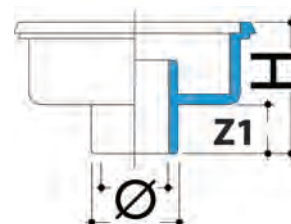

Equipment de sol
Bodemuitrusting

M-F Siphon de cour avec sortie horizontale PVC
M-S Vloerput met horizontale uitgang PVC

Platine Tegel	Grille Rooster	∅ male spie	∅ fem. mof		H		Z1	Ref.		SOSICO
250 x 250	230	100	90	Gris foncé Donkergrijs	192	50	57	SC1925	2	
300 x 300	230	100	90	Gris foncé Donkergrijs	192	50	57	SC1930	2	

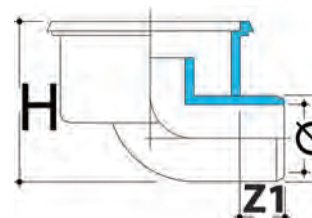



SIPHONS DE COUR PVC POUR L'INTÉRIEUR ET L'EXTÉRIEUR PVC VLOERPUTTEN VOOR BINNEN EN BUITEN

M-F Siphon de cour à panier avec sortie horizontale PVC M-S Vloerput met korf en horizontale uitgang PVC

SOSICO



Platine Tegel	Grille Rooster	Ø male spie	Ø fem. mof		H		Ref.	
200 x 200	110	110	100	Gris foncé Donkergrijs	100		SCP1110	2
200 x 200	110	110	100	Sable Zand	100		SCP11S	2

M-F Receveur siphonné avec sortie verticale PVC M-S Afvalwateropvangner met vertikale uitgang PVC

SOSICO



Platine Tegel	Ø male spie	Ø fem. mof		H		Ref.	
400 x 400	80/100	63/90	Gris clair Lichtgrijs	115		REL	5
400 x 400	80/100	63/90	Sable Zand	115		RELS	5

M Siphon de cour avec sortie verticale PVC/INOX S Vloerput met vertikale uitgang PVC/INOX

SOSICO



Platine Tegel	Grille Rooster	Corps Lichaam	Ø		H			Ref.	
150 x 150	135	130	50	INOX	90		1,36	24170	2
200 x 200	180	172	75	INOX	90		2,42	24180	2
250 x 250	225	201	90	INOX	97		2,9	24190	2

M Siphon de cour + plaque à carreler avec sortie horizontale S Vloerput + vloerplaat met horizontale uitgang PVC/INOX

SOSICO



Platine Tegel	Grille Rooster	Ø		H			Ref.	
150 x 150	223	75	INOX	118		1,36	8213	2
200 x 200	293	90	INOX	140		2,42	8223	2

> Réglable en hauteur à l'aide d'un tube standard

> In de hoogte regelbaar met behulp van standaard buis

M **CLASSE** Siphon de cour avec sortie verticale PVC/FONTE S **CLASSE** **C250** Vloerput met vertikale uitgang PVC/GIETIJZER



SOSICO



Platine Tegel	Ø		H			Ref.	
200 x 200	75	Fonte Gietijzer	104		2,42	24102	1
250 x 250	110	Fonte Gietijzer	115		2,9	24202	1



Siphon de sol grille INOX SORTIE VERTICALE
Vloersifon INOX rooster VERTIKALE UITGANG



	H		ØSortie ØUitg.	H	Z	L1	b1	Ref.		SORDCA
61	45	150 X 150	2	115	0,6	50	50/75	EAS45AI	1	
61	45	100 x 100	1	115	0,6	50	50/75	EAS35AI	1	

- > Possibilité d'ancrage d'une plaque d'étanchéité
- > Plaque d'étanchéité

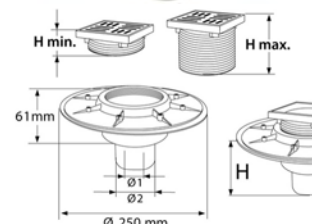
- > Bevestigingsmogelijkheid voor waterdichte slab
- > Dichtingsmembraan



Siphon de sol grille INOX SORTIE HORIZONTALE
Vloersifon INOX rooster HORIZONTALE UITGANG



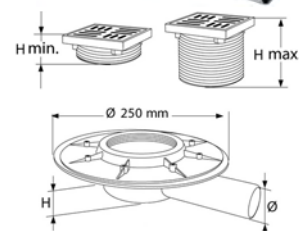

	H		ØSortie ØUitg.	H	Z	L1	b1	Ref.		SORDCA
50	45	150 x 150	30	100	0,6	50	40	EAS24AI	1	
56	45	150 x 150	40	100	0,6	50	50	EAS25AI	1	
50	45	100 x 100	10	100	0,6	50	40	EAS14AI	1	
56	45	100 x 100	20	100	0,6	50	50	EAS15AI	1	

- > Possibilité d'ancrage d'une plaque d'étanchéité
- > Plaque d'étanchéité

- > Bevestigingsmogelijkheid voor waterdichte slab
- > Dichtingsmembraan





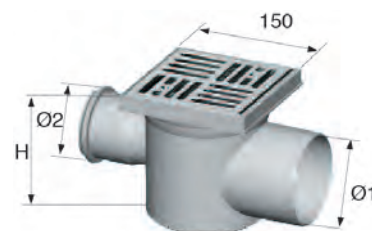

Siphon de cour PP grand débit avec entrée supplémentaire
Vloersifon in PP groot debiet met extra ingang

Grille Rooster	 male spie	 fem. mof		Mat. grille. Rooster	 L/sec	Ref.		SOSICO
150 x 150	75	75	Gris clair Licht grijs	Inox	>1,05	EBA66AI	1	
150 x 150	110	75	Gris clair Licht grijs	Inox	>1,40	EBA88AI	1	
150 x 150	75	75	Gris clair Licht grijs	PP	>1,05	EBA55PP	1	
150 x 150	110	75	Gris clair Licht grijs	PP	>1,40	EBA77PP	1	



Siphon de cour en PP avec entrée supplémentaire
Vloersifon in PP met extra ingang

Grille Rooster	 male spie	 fem. mof		Mat. grille. Rooster	 L/sec	Ref.		SOSICO
100	50	40	Gris clair Licht grijs	Inox	0,6	E2SE5AI	1	
150	50	40	Gris clair Licht grijs	Inox	0,6	E2SE8AI	1	
150	50	40	Gris clair Licht grijs	PP	0,6	E2SE8PP	1	

- > Hauteur de 130 à 200 mm

- > Hoogte van 130 tot 200 mm





Modèle EBA / Model EBA

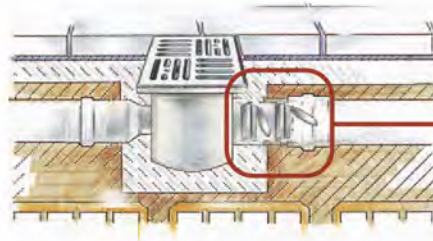
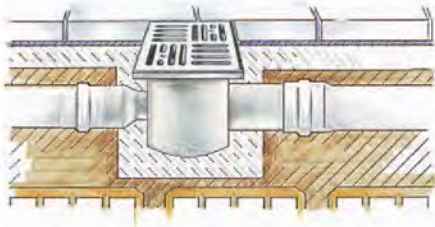

Avantages:

- Entrée supplémentaire pour éviter un siphon à sec et une remontée de mauvaises odeures.
- Grand débit d'évacuation.

Voordelen:

- Extra aansluiting om een droogstaande sifon en slechte geuren te vermijden
- Groot evacuatiedebiet

Modèle E2SE / Model E2SE

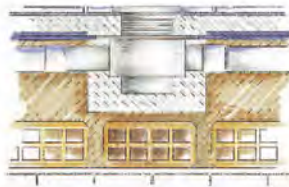

Avantages:

- Entrée supplémentaire pour éviter un siphon à sec et une remontée de mauvaises odeures.
- Plaque d'étanchéité
- Système anti-odeur avec balle



Voordelen:

- Extra aansluiting om een droogstaande sifon en slechte geuren te vermijden
- Plaat voor waterdichtheid
- Systeem tegen slechte geur met balletje

Clapet anti-retour double clapet
Terugslagklep 2 kleppen

SOSICO



Ø	Ref.		
103	EDP1104	6	768
> 2 clapets > Pour tubes Ø 110	> 2 kleppen > Voor buizen Ø 110		



Avec natte d'étanchéité / Met waterdichte film

Avaloir de balcon avec natte GEOTEXTILE
Balkondoorvoer met film GEOTEXTIEL

> Dimension de la natte: 400 x 400 mm

> Afmeting film: 400 x 400 mm



SOSICO

Platine Tegel	Grille Rooster	Ø		H min.	H max.		Ref.	
155 x 155	116 x 116	80	Gris clair Lichtgrijs	160	330	5,5 m ³ /h-u	ABE80	1
155 x 155	116 x 116	80	Blanc Wit	160	330	5,5 m ³ /h-u	ABE80B	1
155 x 155	116 x 116	100	Gris clair Lichtgrijs	160	330	5,5 m ³ /h-u	ABE100	1
155 x 155	116 x 116	100	Blanc Wit	160	330	5,5 m ³ /h-u	ABE100B	1



Sans natte d'étanchéité / Zonder waterdichte film



Avaloir de balcon PVC
Balkondoorvoer PVC

Platine Tegel	Grille Rooster	Ø		H min.	H max.		Ref.	
155 x 155	116 x 116	80	Gris clair Lichtgrijs	160	330	5,5 m ³ /h-u	ABSE80	5
155 x 155	116 x 116	80	Blanc Wit	160	330	5,5 m ³ /h-u	ABSE80B	5
155 x 155	116 x 116	100	Gris clair Lichtgrijs	160	330	5,5 m ³ /h-u	ABSE100	5
155 x 155	116 x 116	100	Blanc Wit	160	330	5,5 m ³ /h-u	ABSE100B	5



SOSICO

Siphon de balcon démontable PVC
Balkonsifon demonteerbaar PVC

Ø			Z	L	Z1	Ref.	
80	Gris clair Lichtgrijs	50	73	50	125	SB80	4
80	Sable Zand	50	73	50	125	SB80S	4
80	Blanc Wit	50	73	50	125	SB80B	4
100	Gris clair Lichtgrijs	50	73	50	115	SB100	4
100	Sable Zand	50	73	50	125	SB100S	4
100	Blanc Wit	50	73	50	125	SB100B	4



SOSICO



Bouche d'arrosage standard ovale
Sproeiput standaard ovaal

SOSICO	Ø	Ref.	
	3/4"	BRM2027	1

- > Robinet avec potence
- > Branchement fem. 3/4" - Sortie male 3/4"
- > *Kraan met kruk*
- > *Aansluiting mof 3/4" - Uitgang spie 3/4"*



Bouche d'arrosage modèle incongelable
Sproeiput vorstvrij model

SOSICO	Ø	H	Ref.	
	3/4"	650	BAI2027	1

- > Robinet avec potence
- > Branchement fem. 3/4" - Sortie male 3/4"
- > Entretien: l'ensemble est démontable sans terrassement
- > *Kraan met kruk*
- > *Aansluiting mof 3/4" - Uitgang spie 3/4"*
- > *Onderhoud: kan langs de kraan gedemonteerd worden*



Bouche d'arrosage modèle rectangulaire
Sproeiput rechthoekig model

SOSICO	Ø		Ref.	
	3/4"	Anthracite / Antraciet	BAC227A	1
	3/4"	Vert / Groen	BAC227	1

- > Robinet avec potence
- > Branchement fem. 3/4" - Sortie male 3/4"
- > *Kraan met kruk*
- > *Aansluiting mof 3/4" - Uitgang spie 3/4"*



Dégraisseur ENDURA en PP
ENDURA vetvanger in PP

SOSICO	Ø	Description Omschrijving		Ref.	
	110	1,6L / sec	600x445x414	DSG16	1
	110	3,2L / sec	788x597x445	DSG32	1

- > Installation en surface ou dans le sol, tout près des appareils
- > Y compris: 2 manchons flexibles Ø 110 + une entrée d'air avec ventilair 50mm
- > 1. Couvercle à clipser en PP renforcé de nylon
- 2. Joint amovible
- 3. Séparation de sortie
- 4. Séparation d'entrée
- 5. Cuve
- > *Installatie dicht bij de toestellen, op de vloer of in de grond*
- > *Inbegrepen: 2 x flexible moffen Ø 110 + een luchttoevoer via de luchtsnuiver 50mm*
- > 1. *Nylon versterkt clipsdeksel in PP*
- 2. *Verwijderbare dichting*
- 3. *Uitlaatschot*
- 4. *Inlaatschot*
- 5. *Bak*

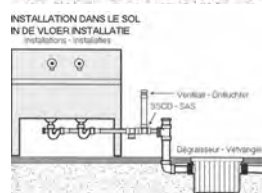
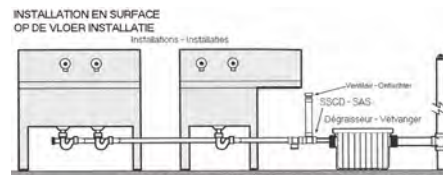
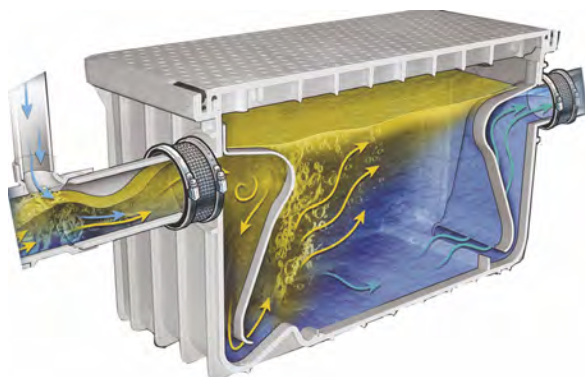

Aliaxis Belgium S.A.

Parc Industriel des Hauts Sarts,
1ère Avenue 106
4040 Herstal
Belgium
+32 (0)4 248 89 40
info.be@aliaxis.com
www.aliaxis.be

